



KERN & Sohn GmbH

Ziegelei 1

D-72336 Balingen

E-Mail: info@kern-sohn.com

Tel: +49-[0]7433-9933-0

Fax: +49-[0]7433-9933-149

Internet: www.kern-sohn.com

Montageanleitung Stativ Tripod assembly manual Instruction d'installation du support vertical

KERN EOC-A05

Version 1.1
12/2016

Deutsch
English
Français



EOC-A05-IA-def-1611

D Weitere Sprachversionen finden Sie online unter **www.kern-sohn.com/manuals**

E Más versiones de idiomas se encuentran online bajo **www.kern-sohn.com/manuals**

F Vous trouverez d'autres versions de langue online sous **www.kern-sohn.com/manuals**

GB Further language versions you will find online under **www.kern-sohn.com/manuals**

I Trovate altre versioni di lingue online in **www.kern-sohn.com/manuals**

PL Inne wersje językowe znajdą Państwo na stronie **www.kern-sohn.com/manuals**

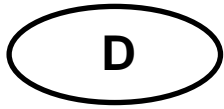

KERN EOC-A05

Version 1.1 12/2016

Montageanleitung Stativ

Inhaltsverzeichnis

1	Technische Daten	2
2	Lieferumfang	3
3	Übersicht	4

1 Technische Daten

KERN	EOC-A05
Stativhöhe	33 cm

2 Lieferumfang

 <p>Stativ</p>	 <p>Halterung Anzeigegerät</p>
 <p>Stativfuss (Abbildung ähnlich)</p>	 <p>Schraube x 1</p>
 <p>Plastik- Zylinder</p>	 <p>Schraube mit Mutter x 1</p>
 <p>Schraube x 4</p>	 <p>Kabelführung mit Schraube je 3 x</p>
 <p>Stützschraube x 1</p>	 <p>x 3</p>

3 Übersicht

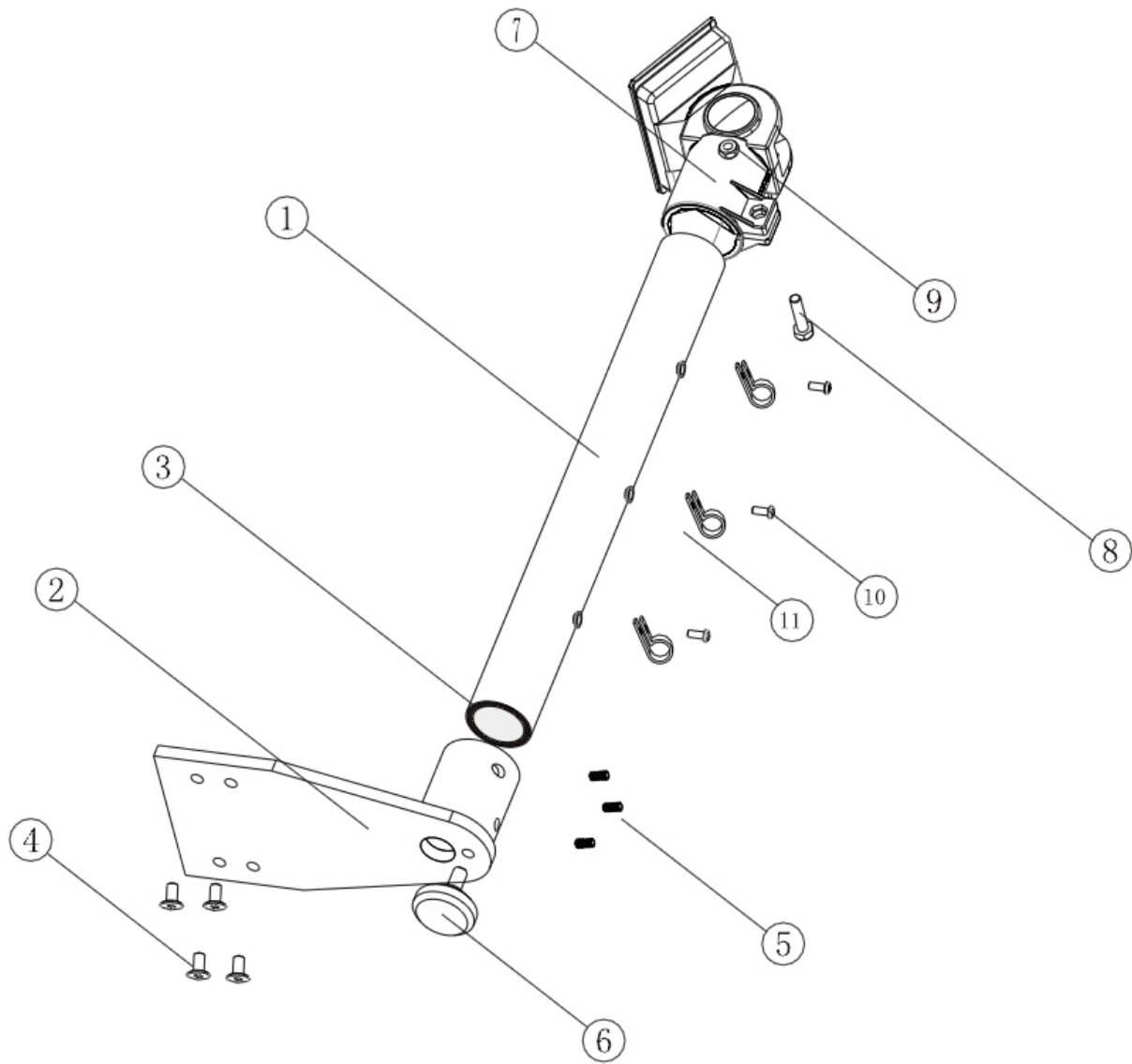

1	Stativ	7	Halterung Anzeigegerät
2	Stativfuß	8	Schraube
3	Plastikring	9	Schraube
4	Schraube	10	Schraube
5	Schraube	11	Kabelführung
6	Stützschraube		





KERN EOC-A05

Version 1.1 12/2016

Tripod assembly manual

Table of contents







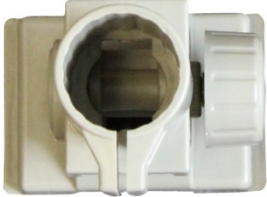

1	Technical data	2
2	Scope of delivery	3
3	Overview	4

English

1 Technical data

KERN	EOC-A05
Tripod height	33 cm

2 Scope of delivery

 <p>Tripod</p>	 <p>Display holder</p>
 <p>Tripod foot (exemplary figure)</p>	 <p>Screw, 1 piece</p>
 <p>Plastic cylinder</p>	 <p>Screw with nut, 1 piece</p>
 <p>Screw, 4 pieces</p>	 <p>Cable guide with screw, 3 pieces each</p>
 <p>Support screw, 1 piece</p>	 <p>x 3</p>

3 Overview

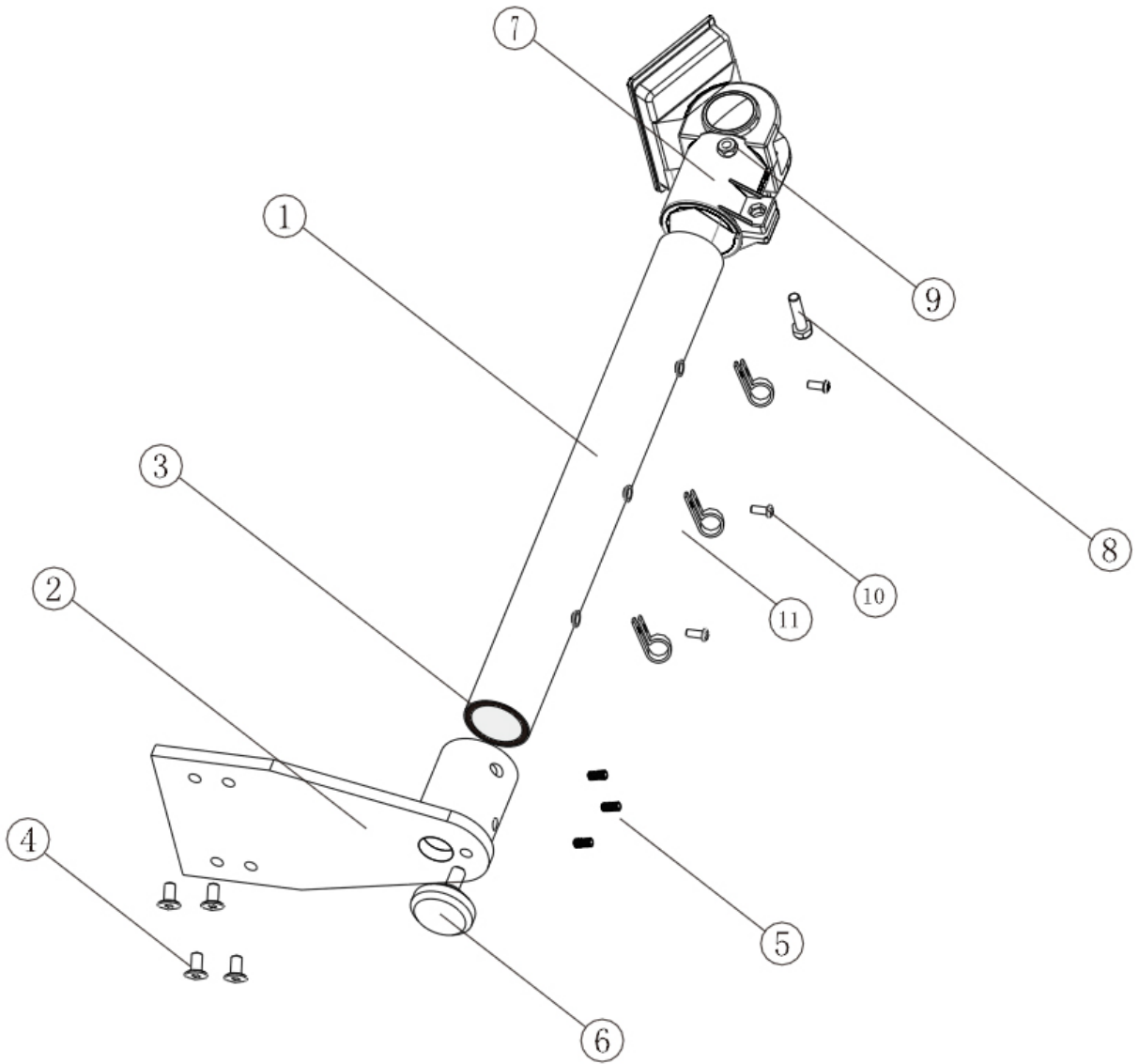

1	Tripod	7	Display holder
2	Tripod foot	8	Screw
3	Plastic ring	9	Screw
4	Screw	10	Screw
5	Screw	11	Cable guide
6	Support screw		





KERN EOC-A05

Version 1.1 12/2016

Instruction d'installation du support vertical







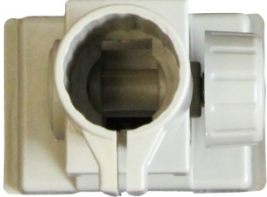

Sommaire

1	Caractéristiques techniques	2
2	Éléments livrés.....	3
3	Aperçu.....	4

1 Caractéristiques techniques

KERN	EOC-A05
Hauteur du support	33 cm

2 Éléments livrés

 <p>Support</p>	 <p>Anneau de fixation du support</p>
 <p>Pied du support (image ressemblant)</p>	 <p>1 vis</p>
 <p>Cylindre en plastique</p>	 <p>1 vis avec écrou</p>
 <p>4 vis (sans dessein)</p>	 <p>3 guides-fils avec vis, 3 fois chacun</p>
 <p>1 vis de fixation</p>	 <p>x 3</p>

3 Aperçu

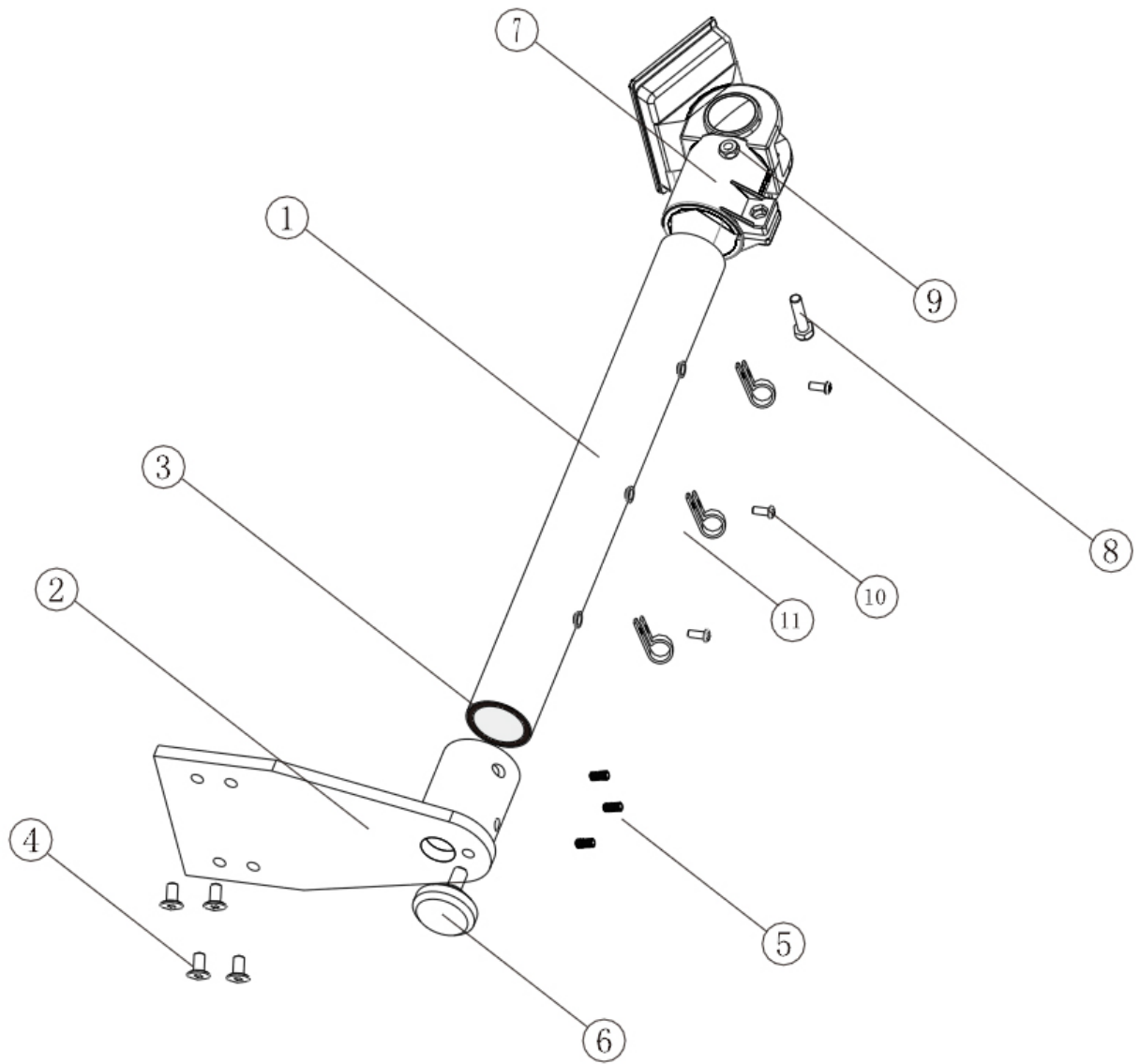

1	Support	7	Anneau de fixation du support
2	Pied du support	8	Vis
3	Anneau en plastique	9	Vis
4	Vis	10	Vis
5	Vis	11	Gide-fil
6	Vis de support		

