



Digital Refractometer



Operating Manual

Content

1. General information	3
2. Introduction	4
3. Display & operating buttons	5
4. Preparing before operating	6
5. Turn on & measure	7
6. Calibration	8
7. Changing scale & temperature unit	10
8. Turning off	11
9. Cleaning & maintenance	11
10. Disposal	11
11. Technical data	12
12. Error codes	12
13. Models and scales	13



Carefully read through the operating manual even if you have prior experience with KERN refractometers.

1. General information

1.1 Intended use

The refractometer is a measuring instrument for determining the refractive index of transparent substances in liquid or in some cases also in the solid state. It is used to observe the behaviour of light as it passes from a prism with known properties to the substance being tested.

Use of the refractometer for other purposes is contrary to its intended use and may be hazardous. The manufacturer shall not be liable for any damages caused by improper use.

1.2 Warranty

The warranty shall be void in the event of:

- Failure to observe the instructions in the operating manual
- Use for purposes other than those described
- Modifications or opening the device housing
- Mechanical damage and/or damage resulting from media, liquids, natural wear and tear

2. Introduction

2.1 Description

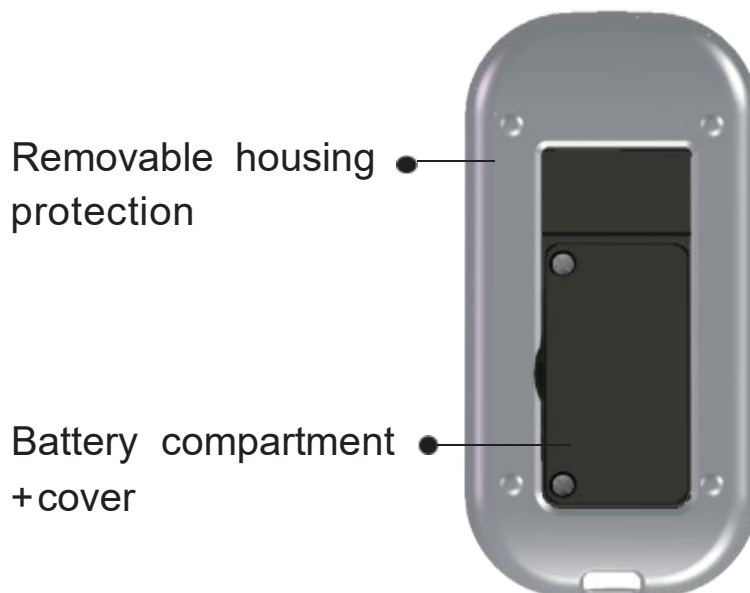



2.2 Scope of delivery

1x Storage box | 1x Digital refractometer |
1x Operating manual | 1x AAA Battery 1.5 V |
1x Pipette | 1x Screwdriver

3. Display & operating buttons

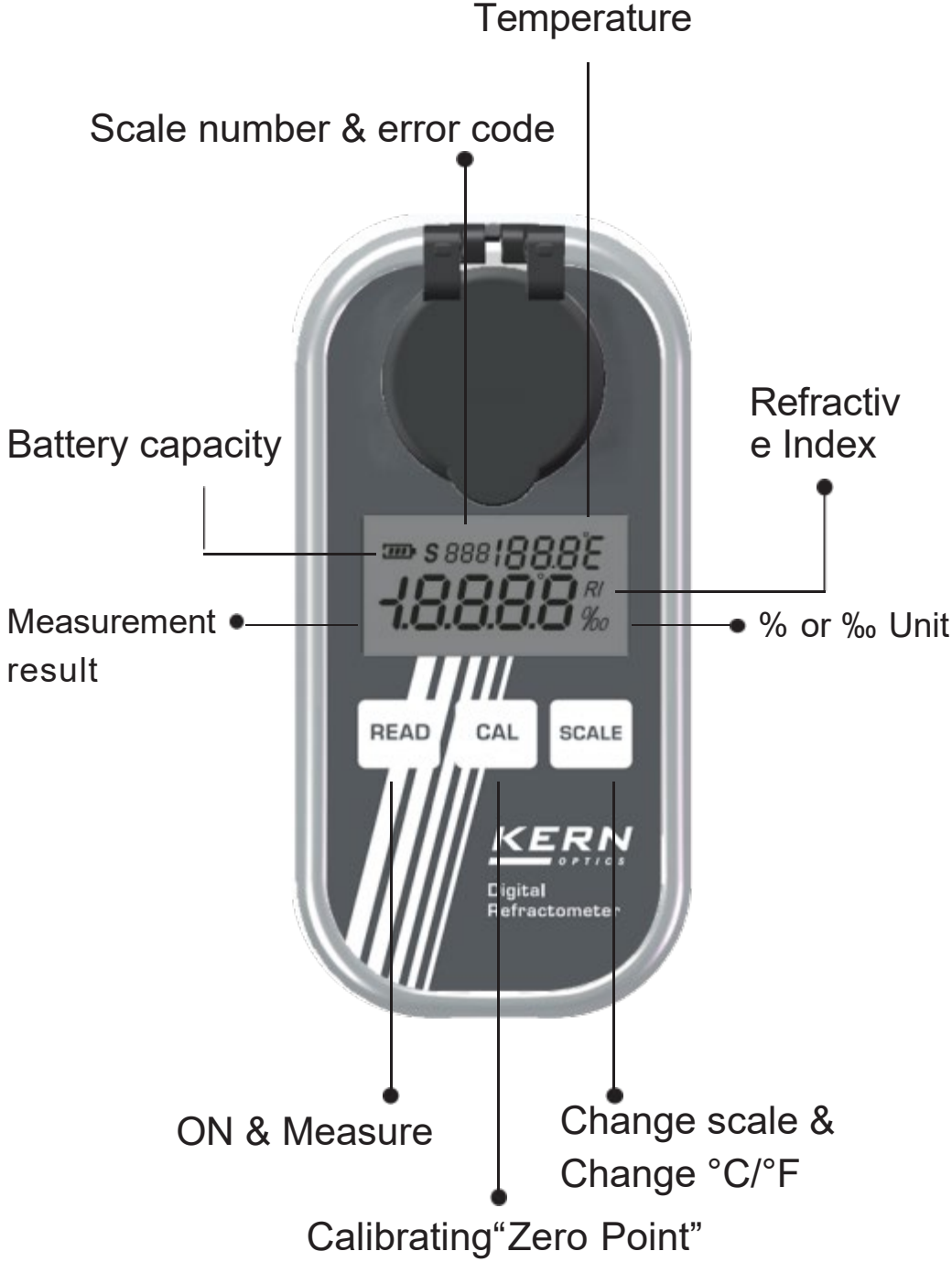
3.1 Description display & operating buttons



 **Note:** Please replace the battery when the  is displayed.

4. Preparing before operating

4.1 Install the battery

Turn the screw counterclockwise to open the battery hatch.

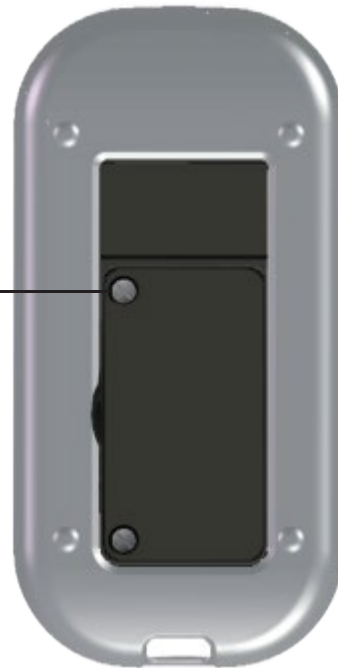

Put 1 piece of 1.5V battery into the cabin in the right way and recover the cabin again.

Only for KERN service staff

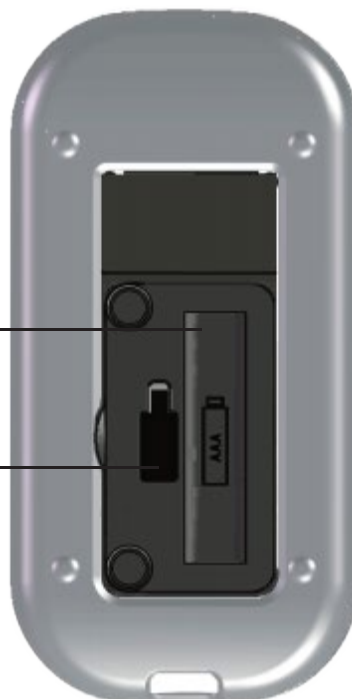

5. Turn on & measure

5.1 Turn on

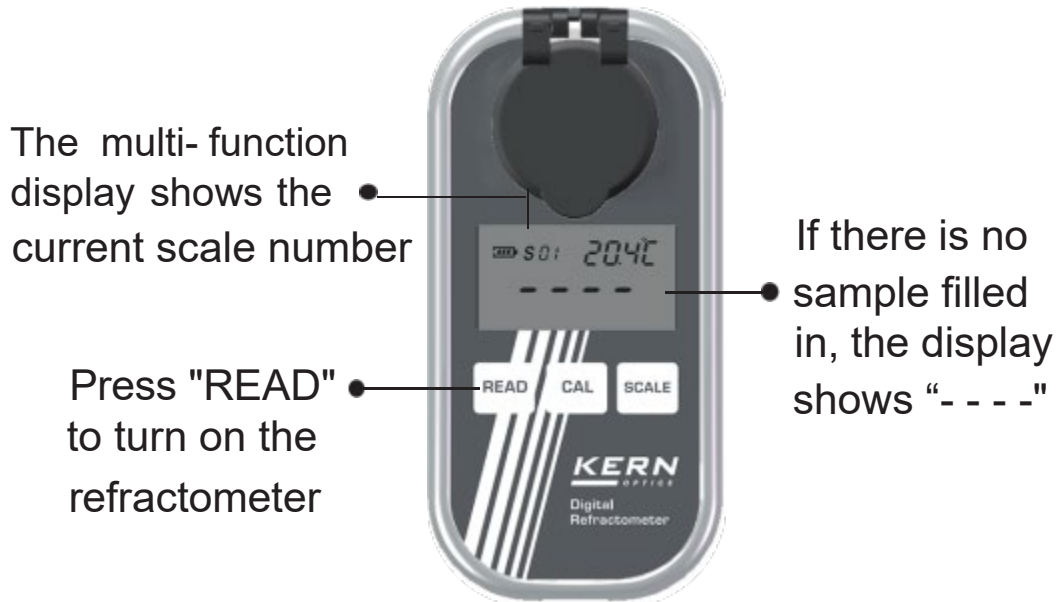

Note :

1. When used outdoors, please avoid strong light so as not to affect the measurement accuracy.
2. Please keep the instrument in a stable and still statement and position.

5.2 Measure

After turning on, clean the sample tank with distilled water and then dry it. Now fill the sample up to the mark, close the cover and press " READ" .



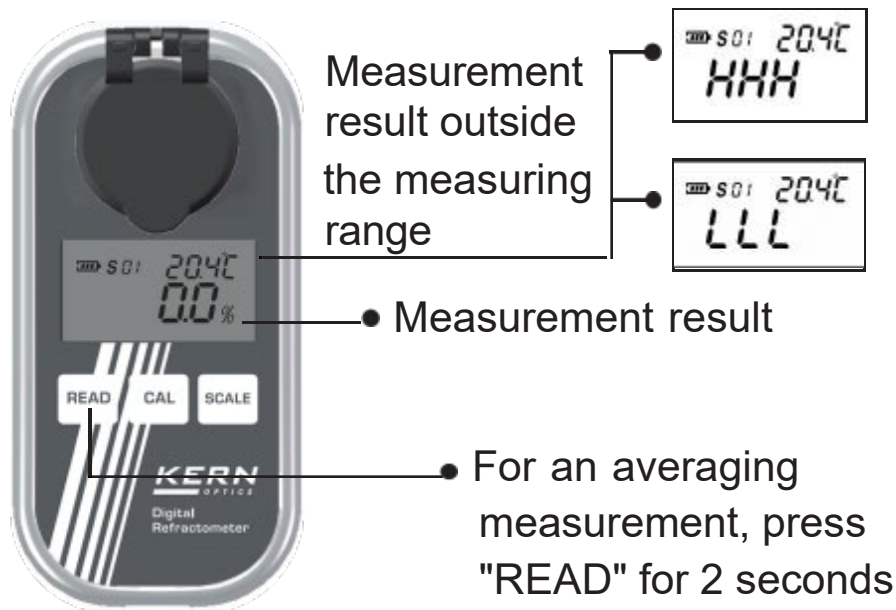

5.3 Average value measurement

Press "READ" for 2 seconds. The device starts an automatic measurement series of 15 measurements and shows the average value. Afterwards, the device automatically turns back to the normal measuring mode.

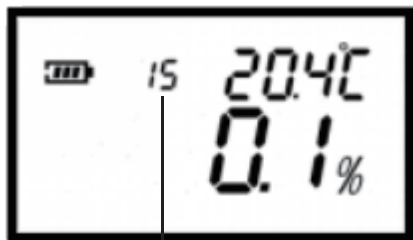

Remaining measurements

6. Calibration

The refractometer can only be calibrated with distilled water. To do this, fill the sample tank with distilled water up to the mark and close the cover.

Press "CAL" for 2 seconds to enter calibration mode. Then press "CAL" again for 2-3 seconds until "CAL" flashes in the display.



LCD Flashing Display

While "CAL" is flashing in the display, press "CAL" again to start the calibration. When the calibration is finished, the display shows "End". After approx. 10 seconds, the device automatically returns to normal mode.

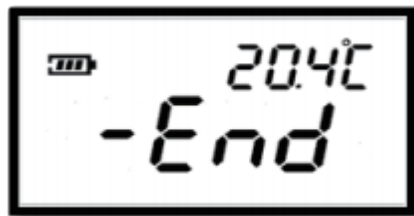

If the calibration was not completed successfully, an error code appears in the display. Here, for example, A01.

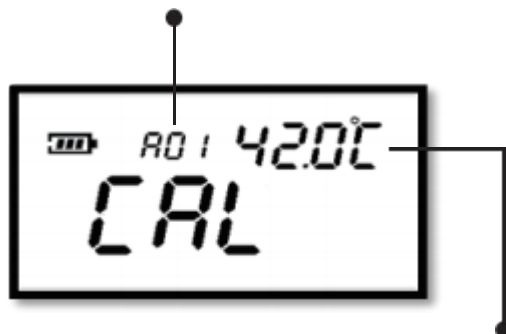

Further error codes can be found in the appendix.

7. Changing scale & temperature unit

7.1 Changing scale

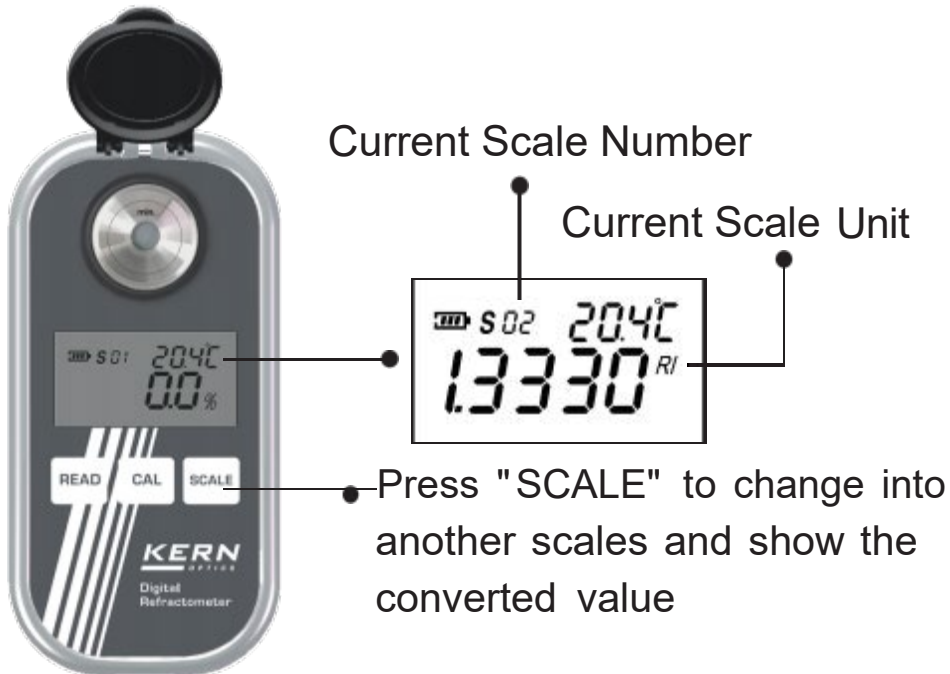

7.2 Changing temperature unit

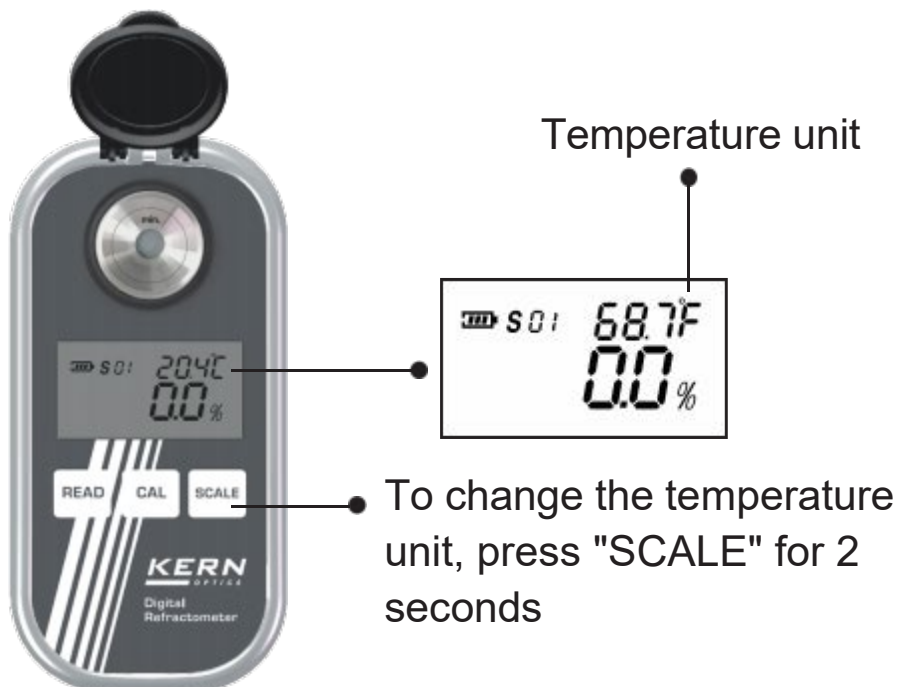

If exceed the temperature limitations, the signs “HHH” or “LLL” would show.

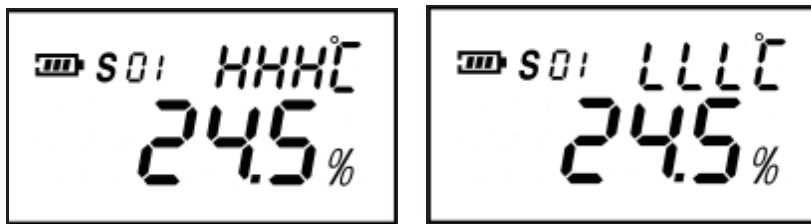

8. Turning off

If without any operations for 1 minute, the instrument would be automatically turned off.

9. Cleaning & maintenance

1. To avoid damages to the prism and the sample tank, clean them with distilled water after each use.
2. Dry it with a soft cloth afterwards.
3. Do not use hard or abrasive objects for cleaning.
4. Do not leave any residue in the sample tank.
5. If the refractometer is not going to be used for a longer time, remove the battery and store it at a cool and dry place.

10. Disposal

The packaging consists of environmentally friendly materials which can be disposed of via local recycling facilities.

The device and storage box should be disposed

of by the operator in accordance with applicable national or regional regulations at the place of use.

NOTE: In accordance with the Battery Ordinance (BattV), batteries must not be disposed of in householdwaste. The end user is legally obliged to return them.

11. Technical data

Scale + accuracy + resolution	Depents to the model
Temperature	0,0 – 40,0 °C / 32,0 – 104,0 ° F
Automatic Temperature Compensation	Yes
Minimum sample volume	0.2 - 0.3 ml (Marking ring)
AUTO-OFF	60 seconds
Averaging measurement	15 measurements
Battery	1 × AAA 1.5 V
Lifetime of the battery	Approx. 10.000 measurements
Overall dimensions L×W×H	125×65×30 mm
Net weight	140 g (without battery)

12. Error codes

code	Instructions
A01	Beyond the scope of calibration temperature. (0.0°C~40.0°C)
A02	During calibration, no solution or solution wrong.
A03	This instrument has a hardware failure.

13. Models and scales

	Model	Scale	No .	Range	Unit	Resolution	Accuracy
	ORM 50BM	Brix	S01	0.0~50.0	%	0.1%	±0.2%
		Refractive Index	S02	1.3330~ 1.4200	nD	0.0001nD	±0.0003nD
	ORM 1RS	Brix	S01	0.0~90.0	%	0.1%	±0.2%
		Refractive Index	S02	1.330~ 1.5177	nD	0.0001nD	±0.0003nD
Fructose	ORM 1SU	Fructose	S01	0.0~68.9	%	0.1%	±0.2%
		Glucose	S02	0.0~59.9	%	0.1%	±0.2%
		Brix	S03	0.0~90.0	%	0.1%	±0.2%
		Refractive Index	S04	1.3330~ 1.5177	nD	0.0001nD	±0.0003nD
	ORM 2SU	Lactose	S01	0.0~ 16.5	%	0.1%	±0.2%
		Maltose	S02	0.0~ 15.6	%	0.1%	±0.2%
		Dextran	S03	0.0~ 10.6	%	0.1%	±0.2%
Honey	ORM 1HO	Honey Water	S01	5.0~38.0	%	0.1%	±0.2%
		Honey Baume	S02	33.0~48.0	°Bé	0.1	±0.2
		Brix	S03	0.0~90.0	%	0.1%	±0.2%
		Refractive Index	S04	1.3330~ 1.5177	nD	0.0001nD	±0.0003nD
Salinity	ORM 1NA	Salinity (NaCl) %	S01	0.0~28.0	%	0.1%	±0.2%
		Salinity (NaCl) ‰	S02	0~280	‰	1‰	±2‰
		Specific Weight	S03	1.000~ 1.220	-	0.001	±0.002
		Brix	S04	0.0~50.0	%	0.1%	±0.2%
		Refractive Index	S05	1.3330~ 1.4200	nD	0.0001nD	±0.0003nD
	ORM 1SW	Salinity Seawater	S01	0~ 100	‰	1‰	±2‰
		Chlorinity Seawater	S02	0~57	‰	1‰	±2‰
		Specific Weight	S03	1.000~ 1.070	-	0.001	±0.002
Brix		S04	0.0~50.0	%	0.1%	±0.2%	
Alcohol	ORM 1AL	Alcohol Mass.	S01	0~72	%	1%	± 1%
		Alcohol Vol.	S02	0~80	%	1%	± 1%
		Brix	S03	0.0~50.0	%	0.1%	±0.2%
		Refractive Index	S04	1.3330~ 1.4200	nD	0.0001nD	±0.0003nD
Beer	ORM 1BR	Plato	S01	0.0~30.5	°P	0.1	±0.3
		SG Wort	S02	1.000~ 1.130	-	0.001	±0.002
		Brix	S03	0.0~50.0	%	0.1%	±0.2%
		Refractive Index	S04	1.3330~ 1.4200	nD	0.0001nD	±0.0003nD
Wine	ORM 1WN	Oechsle	S01	0~ 150	°Oe	1	±2
		Vol%	S02	0.0~22.0	%	0.1%	±0.2%
		KMW (Babo)	S03	0.0~25.0	-	0.1	±0.2
		Brix	S04	0.0~50.0	%	0.1%	±0.2%
	ORM 2WN	Oechsle France	S01	0~230	°Oe	1	±2
		Vol%	S02	0.0~22.0	%	0.1%	±0.2%
		KMW (Babo)	S03	0.0~25.0	-	0.1	±0.2
Coffee	ORM 1CO	Coffee TDS 1	S01	0.0~25.0	-	0.1	±0.2
		Brix	S02	0.0~50.0	%	0.1%	±0.2%
		Refractive Index	S03	1.3330~ 1.4200	nD	0.0001nD	±0.0003nD
	ORM 2CO	Coffee TDS 2	S01	0.00~25.00	-	0.01	±0.20
		Brix	S02	0.00~30.00	%	0.01%	±0.20%
		Refractive Index	S03	1.3330~ 1.4200	nD	0.0001nD	±0.0003nD
Urine	ORM 1UN	Urine Human	S01	1.000~ 1.050	-	0.001	±0.002
		Serum Protein	S02	0.0~ 12.0	g/100ml	0.1	±0.2
		Brix	S03	0.0~50.0	%	0.1%	±0.2%
		Refractive Index	S04	1.3330~ 1.4200	nD	0.0001nD	±0.0003nD
	ORM 2UN	Urine Cat	S01	1.000~ 1.060	-	0.001	±0.002
		Urine Dog	S02	1.000~ 1.060	-	0.001	±0.002
		Brix	S03	0.0~50.0	%	0.1%	±0.2%
Car / Industry	ORM 1CA	Cleaner	S01	(-60.0)~0.0	°C	0.1°C	±0.5°C
		AdBlue®	S02	0.0~51.0	%	0.1%	±0.2%
		Battery Fluid	S03	1.000~ 1.500	-	0.001	±0.005
		Brix	S04	0.0~50.0	%	0.1%	±0.2%
		Refractive Index	S05	1.3330~ 1.4200	nD	0.0001nD	±0.0003nD
		Ethylenglycol (%)	S01	0.0~ 100.0	%	0.1%	±0.5%
	ORM 2CA	Ethylenglycol (°C)	S02	(-50.0)~0.0	°C	0.1°C	±0.5°C
		Propylenglycol (%)	S03	0.0~ 100.0	%	0.1%	±0.5%
		Propylenglycol (°C)	S04	(-60.0)~0.0	°C	0.1°C	±0.5°C
		Brix	S05	0.0~90.0	%	0.1%	±0.2%

